

# Accessories for Health & Safety Vacuum Systems B1

Our safety vacuum systems have been tested in accordance with the German Application Category BIA B1. For health and safety, it is recommended that only special B1 accessories to be used.

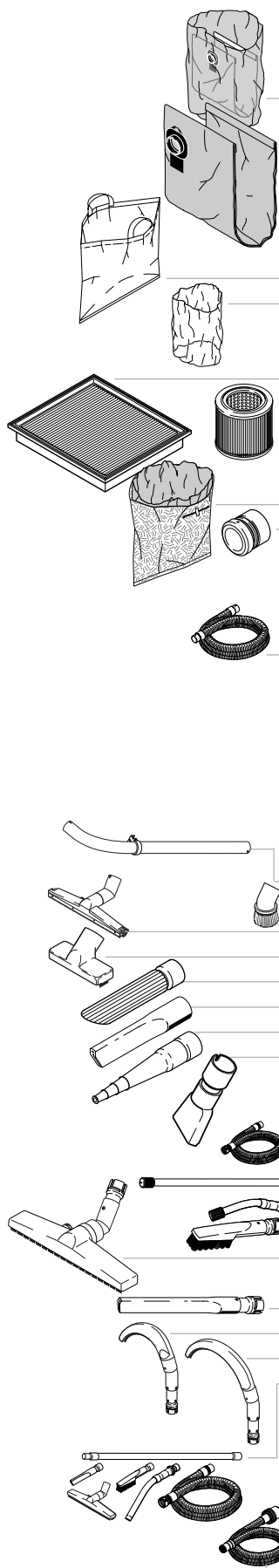

		SQ 690-3M/B1	SQ 890-3M/B1	TURBO D-B1 TURBO D/A-B1	DYNAMICS 440 M/B1 DYNAMICS 840 M/B1	No.
<b>Filter and Accessories</b>						
<b>Safety filter bag *</b>				● ●		5 pieces 33209
2-ply, with film bag, BIA-tested, with sealing cap, for dust-free disposal of substances with TLV values and carcinogenic substances (as per § 35, GefStoffV - German Hazardous Substances Laws, excluding substances as per § 15a GefStoffV)						
<b>Filter bag *</b>	M-tested		●			5 pieces 61603
2-ply, BIA-tested	M-tested	●				5 pieces 60570
<b>Filter support bag</b>			●			60676
<b>Disposal bag for filter element *</b>		○	●	○ ○		10 pieces 30082
<b>Absolute filter element/filter cartridge</b>		●				60077
With filter protection bag				● ●		41164
High Pro Filter			●			61604
	M-tested			● ●		34931
Filter special UP/PTFE	alu.-coated			○ ○		26736
<b>Micro filter element/filter cartridge</b>	H-tested	○				60076
With filter protection bag, BIA-tested	K1, K2			○ ○		11617
<b>Disposal bag *</b>	M-tested			● ●		29727
<b>Reducer B1</b>	70–50 mm			○ ○		29726
<b>Connection - 50 mm dia.</b>		Length				
<b>Suction hose with connection sleeves</b>						
Electrically conductive < 10 <sup>6</sup> ohms	4 m	○	○	○ ○	○ ○	43245
<b>Chip suction hose</b>						
With connection sleeves, abrasion-resistant	4 m	○	○	○ ○	○ ○	42825
	8 m	○	○	○ ○	○ ○	63710
	12 m	○	○	○ ○	○ ○	63711
	16 m	○	○	○ ○	○ ○	63712
	20 m	○	○	○ ○	○ ○	63713
<b>Metal suction hose</b>						
Heat-resistant up to 150 °C, with connection sleeves	4 m	○	○	○ ○	○ ○	42830
<b>Extension tube, curved, Steel, galvanised</b>	1100 mm	○	○	○ ○	○ ○	33609
<b>Suction brush, plastic</b>		○	○	○ ○	○ ○	42831
<b>Industrial roller nozzle with brush strips</b>	500 mm	○	○	○ ○	○ ○	42834
<b>Coarse dirt nozzle</b>	200 mm	○	○	○ ○	○ ○	42835
<b>Diagonal tube nozzle, rubber</b>	330 mm	○	○	○ ○	○ ○	42836
<b>Crevice nozzle, plastic</b>	430 mm	○	○	○ ○	○ ○	42837
<b>Rubber nozzle, round</b>	350 mm	○	○	○ ○	○ ○	42838
<b>Rubber nozzle, flat</b>	200 mm	○	○	○ ○	○ ○	42839
<b>Connection - 36 mm dia.</b>						
<b>Suction hose with connection sleeves</b>						
Electrically conductive < 10 <sup>6</sup> ohms	4 m	○	○	○ ○	○ ○	44193
<b>Extension tube, straight, stainless steel</b>	950 mm	○	○	○ ○	○ ○	46982
<b>Curved hand tube, stainless steel</b>	480 mm	○	○	○ ○	○ ○	44188
<b>Brush nozzle, plastic</b>	230 mm	○	○	○ ○	○ ○	44191
<b>Large-capacity floor nozzle</b>	450 mm	○	○	○ ○	○ ○	44190
With brush strips and height-adjustable castors						
<b>Crevice nozzle, plastic</b>	290 mm	○	○	○ ○	○ ○	44192
<b>Tube cleaning nozzle</b>	70–120 mm	○	○	○ ○	○ ○	48066
<b>Tube cleaning nozzle</b>	120–200 mm	○	○	○ ○	○ ○	48067
<b>B1 set for spark-free vacuum cleaners</b>		○	○	○ ○	○ ○	48907
6-piece, connection 36 mm. dia., 4-m suction hose, anti-static, curved hand tube, extension tube, largecapacity floor nozzle, crevice nozzle, brush nozzle						
<b>Connection - 32 mm dia. with connection sleeves</b>						
<b>Suction hose, electrically conductive &lt; 10<sup>6</sup> ohms</b>	5 m	○	○			48131
<b>Connection - 27 mm dia. with connection sleeves</b>						
<b>Suction hose, electrically conductive &lt; 10<sup>6</sup> ohms</b>	3.5 m	○	○			48132

● Standard accessory      ○ Supplementary accessory

\* New units come equipped with one bag

# Accessory Sets for Vacuum Cleaners

Wet/Dry, Special and Health & Safety Vacuums

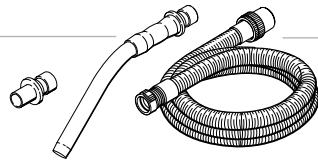

## Hose set

3-piece, **36 mm dia.** connection, 4-m suction hose  
Curved hand tube, stainless steel  
Adapter

**No.**  
63210  
25537  
46691  
29457

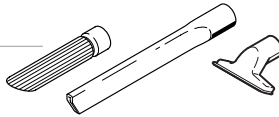

## Car set

3-piece, **36 mm dia.** connection  
Crevice nozzle, 300 mm  
Universal nozzle, plastic  
Diagonal tube nozzle, rubber

**No.**  
63211  
6084  
14295  
5067

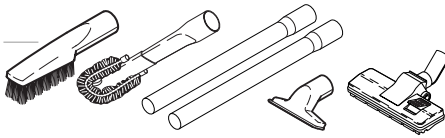

## Home & office set

5-piece, **36 mm dia.** connection  
Suction tubes, aluminium  
Universal nozzle, plastic  
Combination nozzle  
Brush nozzle  
Radiator brush nozzle

**No.**  
63212  
54490  
14295  
8046  
6086  
5144

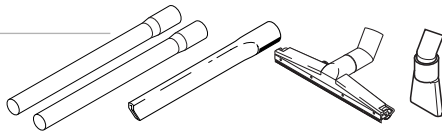
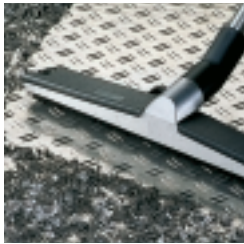

## Trade & industry set

5-piece, **36 mm dia.** connection  
Suction tubes, stainless steel  
Crevice nozzle, plastic  
Large-capacity floor nozzle, with brush strips  
Replacement rubber lips, wet  
Flat rubber nozzle, oil and heat-resistant

**No.**  
63213  
15546  
6084  
15348  
15352  
40456

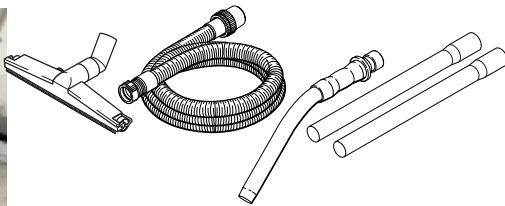

## Industrial/floor set

4-piece, **36 mm dia.** connection  
4-m suction hose, oil-resistant  
Curved hand tube, stainless steel  
Suction tubes, stainless steel  
Large-capacity floor nozzle, with rubber lips

**No.**  
63214  
61779  
46691  
15546  
15349

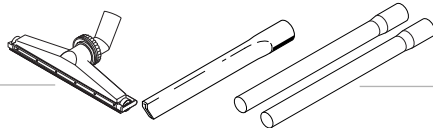

## Water vacuuming set

3-piece, **36 mm dia.** connection  
Suction tubes, stainless steel  
Special floor nozzle, plastic  
Crevice nozzle plastic, 300 mm

**No.**  
7727  
15546  
5149  
6084

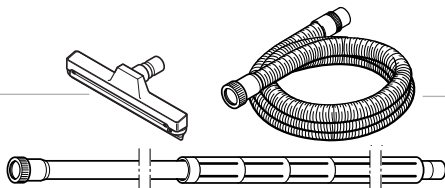

## Oven cleaning set

3-piece, **36 mm dia.** connection  
4-m suction hose  
2-m anodized aluminium extension tube  
Oven nozzle

**No.**  
14341  
6070  
15339  
6079

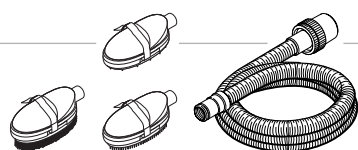

**Animal care set**  
4-piece, **27 mm dia.** connection  
3.5-m suction hose  
Spiked currycomb  
Currycomb  
Brush currycomb

**No.**  
6095  
14289  
6094  
6092  
6093

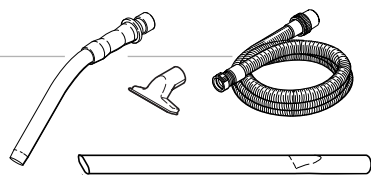

**Heating-boiler cleaning set**  
4-piece, **36 mm dia.** connection  
3-m suction hose  
Hand tube, stainless steel  
Universal nozzle, aluminium  
Crevice nozzle, long metal

60430  
46948  
46691  
5145  
17836

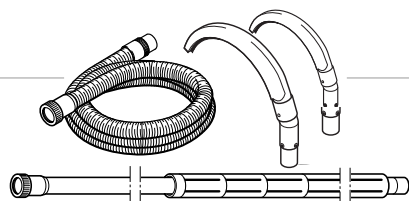

**Pipe cleaning set**  
4-piece, **36 mm dia.** connection, 3-m suction hose  
2.5 m anodized aluminium extension tube  
Tube cleaning nozzles, for 70-120 mm dia.  
for 120-220 mm dia.

63215  
15805  
15340  
7964  
8054

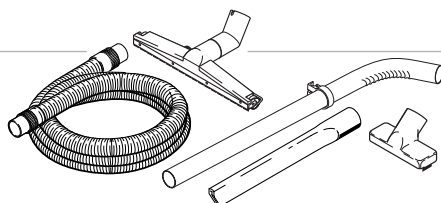

**Industrial set**  
6-piece, **50 mm dia.** connection  
4-m suction hose  
Anodized aluminium extension tube  
Industrial floor nozzle, aluminium  
Replacement rubber lips  
Crevice nozzle, special plastic  
Coarse dirt nozzle, aluminium

63216  
15358  
15335  
15343  
15346  
7102  
41100

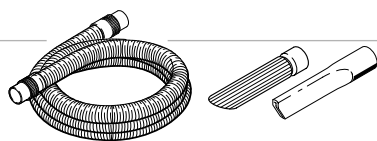

**Standard set**  
3-piece, **50 mm dia.** connection, 4-m suction hose  
Diagonal tube nozzle, rubber  
Crevice nozzle, special plastic

6085  
15358  
7868  
7102

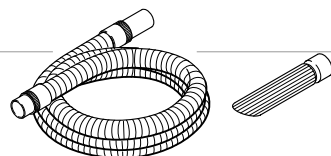

**Chip set**  
2-piece, **50 mm dia.** connection  
4-m aluminium suction hose  
Diagonal tube nozzle, rubber

61681  
15182  
7868

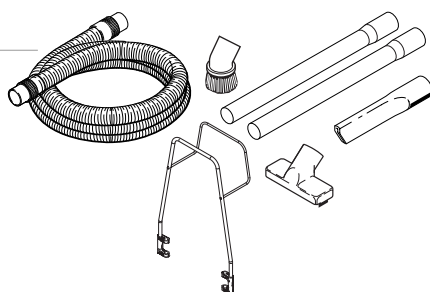

**Bus set**  
6-piece, **50 mm dia.** connection  
16-m suction hose  
2-piece plastic extension tube  
Crevice nozzle, special plastic  
Coarse dirt nozzle, aluminium  
Plastic suction brush  
Hose holder

63217  
5152  
7102  
41100  
40458  
65081

# Accessories for Vacuum Cleaners

Wet/Dry, Special and Health & Safety Vacuums

## Find the right connection

Examples

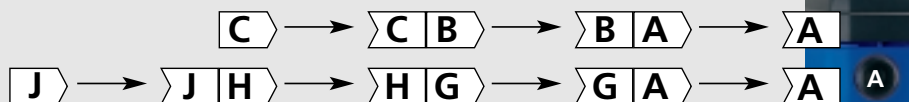

The right fit

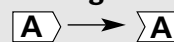

The wrong fit



## DYNAMICS SYSTEM

### System 50



**A** | 070

## ADAPTOR

MultiFIT / DYNAMICS

No.  
29716

## SUCTION NOZZLES for Floor Cleaning

**A**

**Large rolling nozzle**, aluminium, 600 mm wide, with rubber lips  
for SQ 650, SQ 850

29194

TURBO D

14753

**Replacement brush strip (1 piece)**

7993

**Replacement rubber lips (Kit = 2 pieces)**

15814

**C**

**Industrial floor nozzle**, aluminium, 500 mm wide  
Rubber lips and height-adjustable castors,  
for wet vacuuming,

15344

**Replacement rubber lips**

15346

**Replacement castors**

15345

**C**

**Industrial floor nozzle**, aluminium, 500 mm wide  
Brush strips and height-adjustable  
castors, for dry vacuuming

15343

**Replacement brush strips**

15347

**Replacement castors**

15345

**D**

**Floor nozzle**, plastic, 350 mm wide

6077

Brush insert for vacuuming light materials

**D**

**Coarse dirt nozzle**, plastic, 175 mm wide

5153

For light vacuuming of coarse and bulky  
materials (paper, wood wool,  
wood shavings, leaves etc.)

**D** | **C**

**Coarse dirt nozzle**, aluminium, 200 mm wide

41100

Brush insert, professional version

**Replacement brush insert**

41101

## SUCTION NOZZLES

**B**

**Diagonal tube nozzle**, rubber

7868

For vacuuming machines,  
car upholstery etc.

**B**

**Crevice nozzle**, special plastic

7102

Shock and abrasion-proof  
For hard-to-reach places,  
especially for commercial  
car cleaning

**B**

**Rubber nozzle**, round

19936

Oil and heat-resistant  
For hard-to-reach places

**B**

**Rubber nozzle**, flat

31244

Oil and heat-resistant  
For hard-to-reach corners

**B**

**Suction brush**, plastic,

40458

With nylon bristles, for dashboards etc.

## System 50

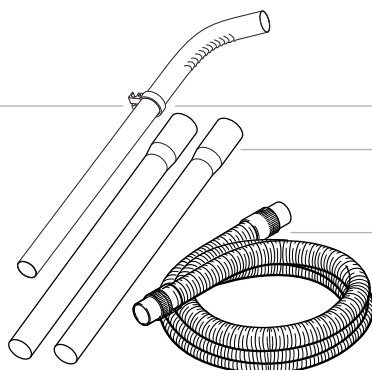

### EXTENSION TUBES

	No.
<b>C   B</b> Curved extension tube Aluminium, 1000 mm long	15335
<b>D   B</b> Extension tube, 2-piece Plastic, 1050 mm long	5152

### SUCTION HOSES - 50 mm dia.

<b>B   A</b> Universal, 1,75 m	19930
<b>B   A</b> Universal, 4 m	15358
<b>B   A</b> Oil-resistant, 4 m	6468
<b>B   A</b> Heat-resistant, 4 m	11061
<b>B   A</b> AntiStatic, 4 m	15815
<b>B   A</b> Chips, 4 m	15182
<b>B   A</b> Metal, 4 m	15013

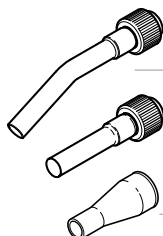

### HAND TUBES - 50/36 mm

<b>H   B</b> Hand tube, curved, Chrome-plated, turnable for connecting 36 mm dia. accessories	15341
<b>H   B</b> Hand tube, straight, Chrome-plated, turnable for connecting 36 mm dia. accessories	15342
<b>H   B</b> Adapter, plastic	40452

## System 38

Pipe cleaning, Oven cleaning

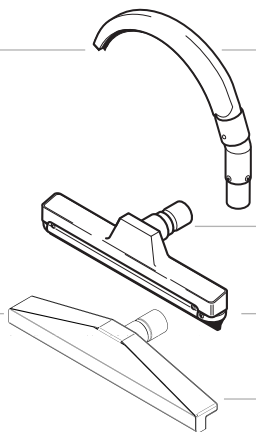

### PIPE CLEANING

<b>F</b> Pipe-cleaning nozzle. For external cleaning of pipes with a dia. of 70 - 120 mm	7964
a dia. of 120 - 200 mm	8054

### OVEN CLEANING

<b>F</b> Oven nozzle, 350 mm wide, with Teflon scraper insert	6079
Replacement scraper insert, Teflon	6080
<b>F</b> Oven nozzle, 350 mm wide, with Stainless steel scraper insert	18790
Replacement scraper insert, stainless steel	18791
<b>F</b> Oven nozzle "XL", 400 mm wide, sturdy nozzle made of stainless steel with stainless steel scraper insert	63380
Replacement scraper insert, stainless steel	64930

### EXTENSION TUBE

<b>F   E</b> Extension tube, aluminium	
With thermal insulation, 2000 mm long	15339
With thermal insulation, 2500 mm long	15340

### SUCTION HOSE - 36 mm dia.

<b>E   A</b> Suction hose, heat-resistant, 4 m	6070
<b>E   A</b> Suction hose, universal, 4 m	15365

### SUCTION HOSES - 32/27 mm dia.

<b>K   A</b> AntiStatic, 32 mm dia. 5 m, with tool adapter	30657
<b>K   A</b> Universal, 27 mm dia. 3.5 m, with tool adapter	14289
<b>K   A</b> AntiStatic, 27 mm dia. 3.5 m, with tool adapter	15325

## System 32/27

Electric tools



# Accessories for Vacuum Cleaners

Wet/Dry, Special and Health & Safety Vacuums

## Find the right connection

Examples

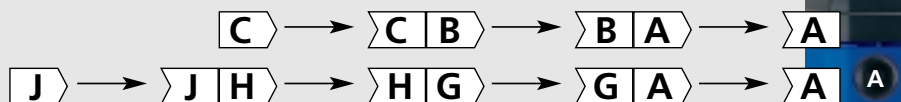

The right fit

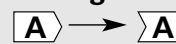

The wrong fit



## System 36

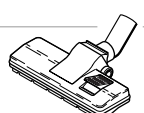

J

### SUCTION NOZZLES for Floor Cleaning

No.

**Combination nozzle**, plastic, 275 mm wide, foot-operated switch-over, thread picker and swivel joint for carpets and smooth floors at home and office

8046

**Replacement thread picker**

64127

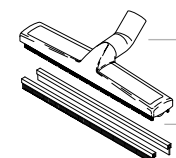

J

**Professional floor nozzle**, plastic, 360 mm wide

60356

Brush strips and rubber lips (replaceable)  
For dry and wet vacuuming

**Replacement brush strips**

60358

**Replacement rubber lips**

60359

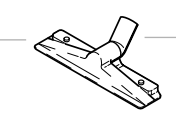

J

**Floor nozzle**, aluminium, 330 mm wide

5147

Removable brush insert

**Replacement brush insert**

6521

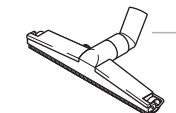

J

**Large-area floor nozzle**, aluminium, 450 mm wide

15349

Rubber lips and height-adjustable castors for wet vacuuming

**Replacement brush strips**

15352

**Replacement castors**

15345

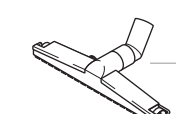

J

**Large-area floor nozzle**, aluminium, 450 mm wide

15348

Brush strips and height-adjustable castors for dry vacuuming

**Replacement brush strips**

15351

**Replacement castors**

15345

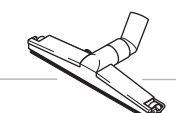

J

**Large-area floor nozzle**, aluminium, 450 mm wide

15350

Special fluff strip and height-adjustable castors for textile floors

**Replacement special fluff strip**

15353

**Replacement castors**

15345

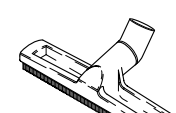

J

**Water suction nozzle**, plastic, 300 mm wide

7270

**Replacement castors**

18794

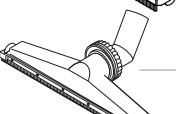

J

**Special floor nozzle**, plastic, 400 mm wide

5149

Corrugated rubber lips and height-adjustable castors for wet and dry vacuuming, especially at building sites

**Replacement rubber lips**

6114

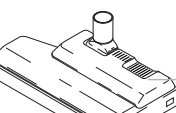

J

**Parquet nozzle**, plastic, 300 mm wide

64195

With long and soft horsehair bristles for a smooth cleaning of sensitive surfaces



J

**Electric suction brush**, 305 mm wide

11664

With brush-and-vacuum function, driven by an electric motor by connection to standard-equipment socket, 230 V

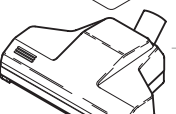

J

**Turbine carpet suction brush**, 300 mm wide

54118

With brush-and-vacuum function, vacuum-driven, with suction power control and cleaning flap

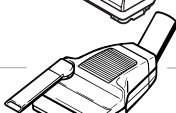

H

### SUCTION NOZZLES







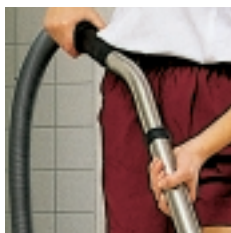
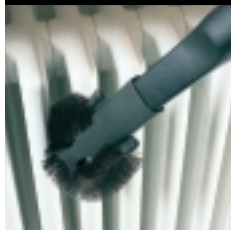

**Turbine hand suction brush**, 150 mm wide



41275

For textile coverings, upholstered furniture etc., vacuum-driven, with integrated swing-out crevice nozzle

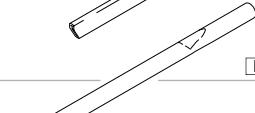

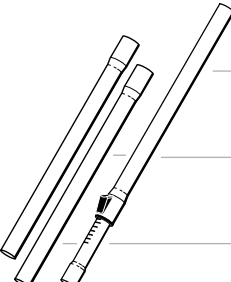

**System 36**

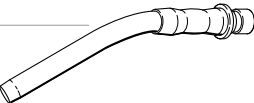

		No.
	<b>SUCTION NOZZLES</b> <b>Brush nozzle</b> , plastic, 230 mm long For delicate parts, upholstery and furniture	6086
	<b>Suction brush</b> , plastic, 70 mm wide With nylon bristles, for dashboards etc.	5146
	<b>Oval brush</b> , plastic, 240 mm wide For cleaning delicate parts with large surfaces	40455
	<b>Radiator brush nozzle</b> , plastic For radiators, blinds etc.	5144
	<b>Universal nozzle</b> , aluminium, 150 mm wide	5145
	<b>Universal nozzle</b> , plastic, 115 mm wide With brush insert, for car upholstery, floor mats etc.	14295
	<b>Crevice nozzle</b> , plastic, 300 mm Shock and abrasion-proof	6084
	<b>Crevice nozzle</b> , chrome-plated, 920 mm long For oven and boiler cleaning	17836
	<b>Diagonal tube nozzle</b> , rubber For vacuuming machines etc., abrasion-proof	5067
	<b>Rubber nozzle</b> , flat, 100 mm wide Oil and heat-resistant	40456

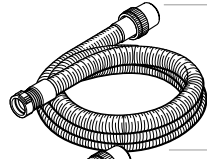
		No.
	<b>EXTENSION TUBES</b> <b>Telescopic tube</b> , stainless steel, 550-970 mm long, With ratchet mechanism	47109
	<b>Straight extension tube</b> , 2-piece, stainless steel, 950 mm long	15546
	<b>Extension tube</b> , 2-piece, aluminium, 950 mm long	54490



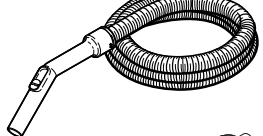

		No.
	<b>HAND TUBE AND ADAPTOR, TURNABLE</b> <b>Adaptor</b> , plastic, for suction hoses with quick system	29457
	<b>Curved hand tube</b> , Stainless steel, with quick system	46691

		No.
	<b>SUCTION HOSES - 36 mm dia.</b> <b>Universal</b> , 3 m, with quick system	46948
	4 m	25537
	<b>Oil-resistant</b> , 4 m, with quick system	61779
	<b>AntiStatic</b> , 3 m, with quick system	60781
	4 m	63209



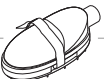



		No.
	<b>SUCTION HOSE - 32 mm dia.</b> <b>Universal with hand tube</b> , 3 m	29743

**System 32/27**

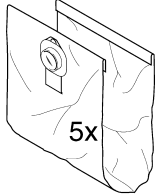

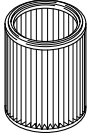
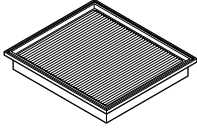
		No.
	<b>ANIMAL CARE NOZZLES</b> For hoses see electric tools page 59 or page 63 <b>Spiked currycomb</b> , plastic, for long fur	6094
	<b>Replacement spiked currycomb insert</b>	15038
	<b>Currycomb</b> , plastic, for long fur	6092
	<b>Replacement currycomb insert</b>	15037
	<b>Brush currycomb</b> , plastic for short fur	6093
	<b>Replacement brush currycomb insert</b>	15039

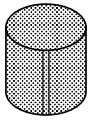
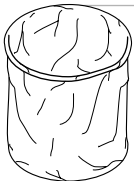
# Accessories for Vacuum Cleaners

			Item No.
	<b>Filter bag</b> 2-ply PU 5 pieces	<ul style="list-style-type: none"> <li>● SQ 450-11, -21, -31, -1M, -2M, -3M</li> <li>● SQ 490-31</li> <li>● SQ 550-11, -21, -31, -2M, -3M</li> <li>● SQ 650-11, -21, -1M, -2M, -3M,</li> <li>● SQ 651-11; SQ 690-31</li> </ul>	29739
	10 pieces Universal bag (3 pcs) for wet dirt	<ul style="list-style-type: none"> <li>● SQ 850-11</li> <li>● TURBO D</li> <li>● AERO 400, AERO 440</li> <li>● AERO 640, AERO 840 A</li> <li>● WD 70-40, WD 70-50</li> <li>● WD 70-40, WD 70-50</li> <li>● FILTRAVAC 14, FILTRAVAC 18</li> </ul>	61603 14912 61156 60910 7090569 7090807 64895
	<b>Filter support bag</b>	<ul style="list-style-type: none"> <li>● SQ 850-11</li> <li>○ TURBO D</li> </ul>	60676 40617
	<b>Safety filter bag</b> Filter material BIA-tested PU 5 pieces	<ul style="list-style-type: none"> <li>○ SQ 450-11, -21, -31, -1M, -2M, -3M</li> <li>○ SQ 490-31</li> <li>● SQ 450-1H, -3H</li> <li>○ SQ 550-11, -21, -31, -2M, -3M</li> <li>○ SQ 650-11, -21, -1M, -2M, -3M; SQ 651-11</li> <li>● SQ 650-1H, -3H</li> <li>○ SQ 690-31</li> <li>○ TURBO D</li> </ul>	60056 49425 60570 33209
	<b>Filter element - Pet fleece</b>	<ul style="list-style-type: none"> <li>● SQ 450-11, -21, -31; SQ 490-31</li> <li>● SQ 450-1M, -2M, -3M; SQ 550-2M, -3M</li> <li>● SQ 650-1M, -3M</li> </ul>	29747 60077
	<b>High-Pro - Pet fleece</b>	<ul style="list-style-type: none"> <li>● AERO</li> <li>● SQ 550-11, -21, -31</li> <li>● SQ 650-11, SQ 651-11, SQ 690-31, -21</li> <li>● SQ 850-11</li> <li>● TURBO D</li> </ul>	11753 61605 41164
	<b>Polyester fleece/PTFE</b>	<ul style="list-style-type: none"> <li>● DYNAMICS 440, -840</li> <li>○ DYNAMICS 440, -840</li> <li>● WD70-40, WD70-50</li> </ul>	34931 26736 7090608
	<b>Micro filter element</b>	<ul style="list-style-type: none"> <li>● SQ 450-1H, -3H; SQ 650-1H, -3H</li> <li>○ AERO</li> <li>○ SQ 550-11, -21, -31</li> <li>○ SQ 650-11, -21, SQ 651-11, SQ 690-31</li> <li>○ TURBO D</li> </ul>	60076 40181
	<b>Hepa</b>	<ul style="list-style-type: none"> <li>● WD 70-40, WD 70-50</li> </ul>	11617 7090564
	<b>Hose holder</b>	for all SQ 6 and SQ 8 types. Puts long hoses in order while transporting	65081
	<b>Filter element protective covering</b> Cloth filter for protection of the filter cartridge. Best suitable for dust with fibres and for coarse dust	<ul style="list-style-type: none"> <li>○ AERO</li> <li>○ SQ 450-11, -21, -31; SQ 490-31</li> <li>○ SQ 550-11, -21, -31</li> <li>○ TURBO D</li> </ul>	11801 11641
	<b>Filter sieve</b>	<ul style="list-style-type: none"> <li>○ SQ 450-11, -21, -31; SQ 490-31*</li> <li>○ SQ 550-11, -21, -31</li> <li>○ SQ 650-11, -21, SQ 651-11</li> <li>● SQ 650-61, -71</li> <li>○ TURBO D</li> </ul>	15475 10022
	<b>Disposal Bag (5 pcs)</b>	● SELFSERVICE VAC	64380
	<b>Cloth filter insert</b> Cotton. Best suitable for dust with high temperatures and for abrasive dust.	<ul style="list-style-type: none"> <li>○ SQ 550-11, -21, -31</li> <li>○ SQ 650-11, -21, SQ 651-11, SQ 690-31</li> <li>○ TURBO D</li> </ul>	17081 8727
	<b>Cloth filter insert - special</b> Needled felt, plastic coated. Best suitable for very fine dust, hygroscopic dust and adhesive dust. High level filtration efficiency.	<ul style="list-style-type: none"> <li>○ SQ 550-11, -21, -31</li> <li>○ SQ 650-11, -21, SQ 651-11, SQ 690-31</li> <li>○ SQ 850-11</li> <li>○ SELFSERVICE VAC</li> </ul>	17068 61910 64009
	<b>Cloth filter insert - super</b> Polyester satin cloth. Best suitable for coarse dust and abrasive dust	<ul style="list-style-type: none"> <li>○ SQ 550-11, -21, -31</li> <li>○ SQ 650-11, -21, SQ 651-11, SQ 690-31</li> <li>○ TURBO D</li> </ul>	17580 17582
	<b>Cloth filter polyester</b>	● WD 70-40, WD 70-50	7090558
	<b>Chip basket</b> For separating chips from coolant during chip extraction and for unit protection. Of galvanised perforated plate, with sturdy carrying handles	<ul style="list-style-type: none"> <li>○ SQ 650-11, -21 SQ 651-11, SQ 690-31</li> <li>○ SQ 850-11</li> </ul>	29193 61463
<b>Accessory basket</b>	For all SQ4, SQ5, SQ6 types except safety vacuums and EC-driven vacuums		61665

● **Standard accessories** (New units come equipped with a bag)

○ **Supplementary accessories**

\* With SQ 4 filter cover no 11762 required

# Suction Hose Systems

Wet/Dry, Special and Health & Safety Vacuums

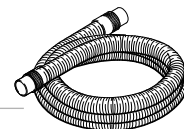

Lengths as required	Nozzle-side sleeve		By the metre max. 20 mtr		Vacuum-side sleeve		complete	
		No.		No.		No.	m	No.
<b>System 70</b> Universal		42419		34947		34955		
<b>System 50</b> Universal		15101		11984		15101	1.75	19930
oil-resistant		15101		14238		15101	4	15358
heat-resistant	aluminium	7162		14238		7162	4	6468
AntiStatic		15811		7599		15811	4	11061
chips	aluminium	33435		15309		14630 alu.	4	15815
metal	aluminium	15015		15310		15015 alu.	4	15013
<b>System 38</b>								
<b>System 36</b> <b>Hose DN 36</b>								
Universal		**46690		11985		15102	3	46948**
oil-resistant		**46690		6429		15102	4	25537**
heat-resistant	aluminium	***7674		6429		7673	4	61779**
AntiStatic	anti-kink spring	***14194					4	6070***
electric tool	connection DN 33-36	48070		15312		15812	3	60781**
DN 35-40 + 49		48750					4	63209**
<b>Hose DN 32</b>								
Universal		**46947		14240		15103		
AntiStatic	hand tube	26897					3	29743
	electric tool	30971		43502		30928	5	30657
<b>System 27</b> Universal	electric tool	18195		15307		15104	3.5	14289
AntiStatic	electric tool	18195		15326		15369	3.5	15325

\*\* Quick system for hand tube 46691 or adapter 29457    \*\*\* Only for oven and pipe cleaning

## HOSE CONNECTION AND DISTRIBUTORS

